



NETWORK WITH US



## MAILBOXES

CASELLE POSTALI · BOÎTES POSTALES · FLACHKASTEN  
BUZONES POSTALES · CASILLAS POSTALES · BRIEVENBUSSEN



# MAILBOX KEYS

All keys are in 1:1 scale



FOR -



8 0 0 3 7 3 6 2 0 8 6 0 5



1000

FOR -



8 0 0 3 7 3 6 2 0 8 6 3 6



1003P

FOR -



8 0 0 3 7 3 6 3 4 4 5 2 5



1008

FOR -



8 0 0 3 7 3 6 2 0 8 7 0 4



1012

FOR -



8 0 0 3 7 3 6 2 0 8 6 1 2

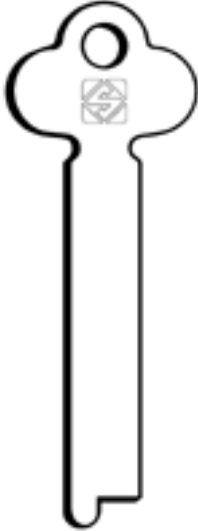

1001

FOR -



8 0 0 3 7 3 6 2 0 8 6 4 3



1003P1

FOR -



8 0 0 3 7 3 6 2 0 8 6 9 8



1009

FOR -



8 0 0 3 7 3 6 2 0 8 7 1 1



1013

In compliance with current regulations relating to industrial property, we hereby state that the trade-marks or trade names mentioned in this document are the exclusive property of authorized manufacturers of locks and users. Said trade-marks or trade names are nominated only for the purposes of information so that any lock for which our keys are made can be rapidly identified. This document is reserved exclusively for professional key cutters who use Silca products. / All information and illustrations in this document are for guidance only. Silca reserves the right to alter products designs, dimensions or info to improve the products quality. The contents of this document are fully protected by Copyright and may not be copied or reproduced in any form, without written permission from Silca S.p.A. Any controversy shall be settled by the Courts of Justice where the company Silca S.p.A. has its headquarters, with express exclusion of any other court.

# MAILBOX KEYS

All keys are in 1:1 scale

FOR -

8 0 0 3 7 3 6 3 5 6 0 6 1

**1014**

FOR -

8 0 0 3 7 3 6 4 6 5 3 2 9

**1016**

FOR ALUBOX®

8 0 0 3 7 3 7 7 2 5 2 5 5

**ALU1**

FOR ARMSTRONG®

8 0 0 3 7 3 7 4 6 7 7 6 6

**ART1R**

FOR -

8 0 0 3 7 3 6 2 0 8 7 3 5

**1015**

FOR -

8 0 0 3 7 3 6 5 6 4 6 0 2

**NR1R**

FOR ARMSTRONG®

8 0 0 3 7 3 7 6 3 7 8 4 8

**ART1**

FOR ASSA®

8 0 0 3 7 3 7 8 5 0 5 1 3

**ASS187R**

In compliance with current regulations relating to industrial property, we hereby state that the trade-marks or trade names mentioned in this document are the exclusive property of authorized manufacturers of locks and users. Said trade-marks or trade names are nominated only for the purposes of information so that any lock for which our keys are made can be rapidly identified. This document is reserved exclusively for professional key cutters who use Silca products. / All information and illustrations in this document are for guidance only. Silca reserves the right to alter products designs, dimensions or info to improve the products quality. The contents of this document are fully protected by Copyright and may not be copied or reproduced in any form, without written permission from Silca S.p.A. Any controversy shall be settled by the Courts of Justice where the company Silca S.p.A. has its headquarters, with express exclusion of any other court.

# MAILBOX KEYS

All keys are in 1:1 scale



FOR BURG®



8 0 0 3 7 3 7 5 1 6 4 0 2



**BUR28R**

FOR BURG®



8 0 0 3 7 3 7 5 5 0 1 7 8



**BUR31R**

FOR CAS-CISMA®



8 0 0 3 7 3 6 0 4 1 0 9 7



**CIS1**

FOR CAS-CISMA®



8 0 0 3 7 3 6 0 4 1 1 3 4



**CIS3**

FOR BURG®



8 0 0 3 7 3 7 5 5 0 1 5 4



**BUR31**

FOR CAB®



8 0 0 3 7 3 6 0 3 0 2 9 9



**CAB1**

FOR CAS-CISMA®



8 0 0 3 7 3 6 0 4 1 1 1 0



**CIS2**

FOR CAS-CISMA®



8 0 0 3 7 3 6 0 4 1 1 5 8



**CIS4**

In compliance with current regulations relating to industrial property, we hereby state that the trade-marks or trade names mentioned in this document are the exclusive property of authorized manufacturers of locks and users. Said trade-marks or trade names are nominated only for the purposes of information so that any lock for which our keys are made can be rapidly identified. This document is reserved exclusively for professional key cutters who use Silca products. / All information and illustrations in this document are for guidance only. Silca reserves the right to alter products designs, dimensions or info to improve the products quality. The contents of this document are fully protected by Copyright and may not be copied or reproduced in any form, without written permission from Silca S.p.A. Any controversy shall be settled by the Courts of Justice where the company Silca S.p.A. has its headquarters, with express exclusion of any other court.

# MAILBOX KEYS

All keys are in 1:1 scale

FOR CAS-CISMA®



CIS4R

FOR CASELLARIO®

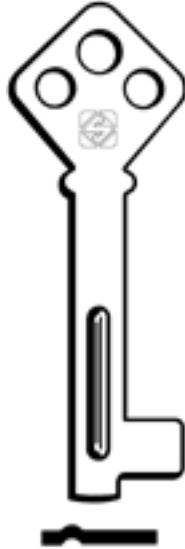

1005

FOR CHICAGO®

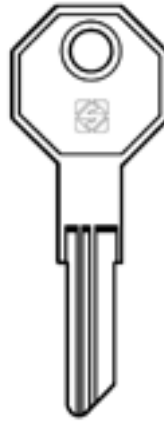

CH15

FOR CINA®



RC6

FOR CASELLARIO®

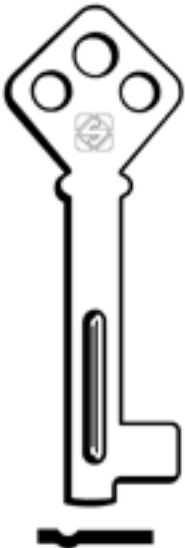

1004

FOR CASH BOX®



CAX1R

FOR CINA®



RC13R

FOR CINA®



RC6R

# MAILBOX KEYS

All keys are in 1:1 scale



FOR CINA®



8 0 0 3 7 3 7 7 5 2 9 5 4



RC7R

FOR CLAUSOR®



8 0 0 3 7 3 6 0 4 2 2 6 1



CR2R

FOR COUILLET®



8 0 0 3 7 3 7 4 8 0 3 3 8



CU402

FOR COUILLET®



8 0 0 3 7 3 7 4 8 0 4 0 6



CU409

FOR CISA®



8 0 0 3 7 3 6 0 4 2 5 5 1



CS1003

FOR COUILLET®



8 0 0 3 7 3 6 2 9 4 9 4 3



CU401

FOR COUILLET®



8 0 0 3 7 3 7 4 8 0 3 6 9



CU405

FOR COUILLET®



8 0 0 3 7 3 6 8 5 4 7 2 7



CU413

In compliance with current regulations relating to industrial property, we hereby state that the trade-marks or trade names mentioned in this document are the exclusive property of authorized manufacturers of locks and users. Said trade-marks or trade names are nominated only for the purposes of information so that any lock for which our keys are made can be rapidly identified. This document is reserved exclusively for professional key cutters who use Silca products. / All information and illustrations in this document are for guidance only. Silca reserves the right to alter products designs, dimensions or info to improve the products quality. The contents of this document are fully protected by Copyright and may not be copied or reproduced in any form, without written permission from Silca S.p.A. Any controversy shall be settled by the Courts of Justice where the company Silca S.p.A. has its headquarters, with express exclusion of any other court.

# MAILBOX KEYS

All keys are in 1:1 scale

FOR CUILLET®

8 0 0 3 7 3 7 4 8 0 3 4 5

**CU403**

FOR CUILLET®

8 0 0 3 7 3 7 4 8 0 3 7 6

**CU406**

FOR CUILLET®

8 0 0 3 7 3 7 4 8 0 3 9 0

**CU408**

FOR CUILLET®

8 0 0 3 7 3 7 4 8 0 4 2 0

**CU412**

FOR CUILLET®

8 0 0 3 7 3 7 4 8 0 3 5 2

**CU404**

FOR CUILLET®

8 0 0 3 7 3 7 4 8 0 3 8 3

**CU407**

FOR CUILLET®

8 0 0 3 7 3 7 4 8 0 4 1 3

**CU411**

FOR CUIRASSEE®

8 0 0 3 7 3 6 7 8 3 9 9 7

**CRE401**

In compliance with current regulations relating to industrial property, we hereby state that the trade-marks or trade names mentioned in this document are the exclusive property of authorized manufacturers of locks and users. Said trade-marks or trade names are nominated only for the purposes of information so that any lock for which our keys are made can be rapidly identified. This document is reserved exclusively for professional key cutters who use Silca products. / All information and illustrations in this document are for guidance only. Silca reserves the right to alter products designs, dimensions or info to improve the products quality. The contents of this document are fully protected by Copyright and may not be copied or reproduced in any form, without written permission from Silca S.p.A. Any controversy shall be settled by the Courts of Justice where the company Silca S.p.A. has its headquarters, with express exclusion of any other court.



# MAILBOX KEYS

All keys are in 1:1 scale



FOR CUIRASSEE®



**CRE402**

FOR CUIRASSEE®



**CRE404**

FOR CUIRASSEE®



**CRE406**

FOR DOBLINA®



**DB1**

FOR CUIRASSEE®



**CRE403**

FOR CUIRASSEE®



**CRE405**

FOR DAD®



**DD8**

FOR DOBLINA®



**DB10**

In compliance with current regulations relating to industrial property, we hereby state that the trade-marks or trade names mentioned in this document are the exclusive property of authorized manufacturers of locks and users. Said trade-marks or trade names are nominated only for the purposes of information so that any lock for which our keys are made can be rapidly identified. This document is reserved exclusively for professional key cutters who use Silca products. / All information and illustrations in this document are for guidance only. Silca reserves the right to alter products designs, dimensions or info to improve the products quality. The contents of this document are fully protected by Copyright and may not be copied or reproduced in any form, without written permission from Silca S.p.A. Any controversy shall be settled by the Courts of Justice where the company Silca S.p.A. has its headquarters, with express exclusion of any other court.



# MAILBOX KEYS

All keys are in 1:1 scale

FOR DOBLINA®



**DB10R**

FOR DOBLINA®



**DB11R**

FOR DOBLINA®



**DB12R**

FOR DOBLINA®



**DB13R**

FOR DOBLINA®



**DB11**

FOR DOBLINA®



**DB12**

FOR DOBLINA®



**DB13**

FOR DOBLINA®



**DB14**

In compliance with current regulations relating to industrial property, we hereby state that the trade-marks or trade names mentioned in this document are the exclusive property of authorized manufacturers of locks and users. Said trade-marks or trade names are nominated only for the purposes of information so that any lock for which our keys are made can be rapidly identified. This document is reserved exclusively for professional key cutters who use Silca products. / All information and illustrations in this document are for guidance only. Silca reserves the right to alter products designs, dimensions or info to improve the products quality. The contents of this document are fully protected by Copyright and may not be copied or reproduced in any form, without written permission from Silca S.p.A. Any controversy shall be settled by the Courts of Justice where the company Silca S.p.A. has its headquarters, with express exclusion of any other court.

# MAILBOX KEYS

All keys are in 1:1 scale



FOR DOBLINA®



8 0 0 3 7 3 6 0 5 3 2 8 1



**DB14R**

FOR DOBLINA®



8 0 0 3 7 3 6 0 5 3 3 2 8



**DB15R**

FOR DOBLINA®



8 0 0 3 7 3 6 0 5 3 3 6 6



**DB16R**

FOR DOBLINA®



8 0 0 3 7 3 6 0 5 3 4 0 3



**DB17R**

FOR DOBLINA®



8 0 0 3 7 3 6 0 5 3 3 1 1



**DB15**

FOR DOBLINA®



8 0 0 3 7 3 6 0 5 3 3 4 2



**DB16**

FOR DOBLINA®



8 0 0 3 7 3 6 0 5 3 3 9 7



**DB17**

FOR DOBLINA®



8 0 0 3 7 3 6 0 5 3 4 2 7



**DB18**

In compliance with current regulations relating to industrial property, we hereby state that the trade-marks or trade names mentioned in this document are the exclusive property of authorized manufacturers of locks and users. Said trade-marks or trade names are nominated only for the purposes of information so that any lock for which our keys are made can be rapidly identified. This document is reserved exclusively for professional key cutters who use Silca products. / All information and illustrations in this document are for guidance only. Silca reserves the right to alter products designs, dimensions or info to improve the products quality. The contents of this document are fully protected by Copyright and may not be copied or reproduced in any form, without written permission from Silca S.p.A. Any controversy shall be settled by the Courts of Justice where the company Silca S.p.A. has its headquarters, with express exclusion of any other court.



# MAILBOX KEYS

All keys are in 1:1 scale

FOR DOBLINA®



DB18R

FOR DOBLINA®



DB19R

FOR DOBLINA®



DB2

FOR DOBLINA®



DB20R

FOR DOBLINA®



DB19

FOR DOBLINA®



DB1R

FOR DOBLINA®



DB20

FOR DOBLINA®



DB21

In compliance with current regulations relating to industrial property, we hereby state that the trade-marks or trade names mentioned in this document are the exclusive property of authorized manufacturers of locks and users. Said trade-marks or trade names are nominated only for the purposes of information so that any lock for which our keys are made can be rapidly identified. This document is reserved exclusively for professional key cutters who use Silca products. / All information and illustrations in this document are for guidance only. Silca reserves the right to alter products designs, dimensions or info to improve the products quality. The contents of this document are fully protected by Copyright and may not be copied or reproduced in any form, without written permission from Silca S.p.A. Any controversy shall be settled by the Courts of Justice where the company Silca S.p.A. has its headquarters, with express exclusion of any other court.

# MAILBOX KEYS

All keys are in 1:1 scale



FOR DOBLINA®



**DB21R**

FOR DOBLINA®



**DB22R**

FOR DOBLINA®



**DB23R**

FOR DOBLINA®



**DB24R**

FOR DOBLINA®



**DB22**

FOR DOBLINA®



**DB23**

FOR DOBLINA®



**DB24**

FOR DOBLINA®



**DB25**

In compliance with current regulations relating to industrial property, we hereby state that the trade-marks or trade names mentioned in this document are the exclusive property of authorized manufacturers of locks and users. Said trade-marks or trade names are nominated only for the purposes of information so that any lock for which our keys are made can be rapidly identified. This document is reserved exclusively for professional key cutters who use Silca products. / All information and illustrations in this document are for guidance only. Silca reserves the right to alter products designs, dimensions or info to improve the products quality. The contents of this document are fully protected by Copyright and may not be copied or reproduced in any form, without written permission from Silca S.p.A. Any controversy shall be settled by the Courts of Justice where the company Silca S.p.A. has its headquarters, with express exclusion of any other court.

# MAILBOX KEYS

All keys are in 1:1 scale

FOR DOBLINA®



**DB25R**

FOR DOBLINA®



**DB26R**

FOR DOBLINA®



**DB27R**

FOR DOBLINA®



**DB28R**

FOR DOBLINA®



**DB26**

FOR DOBLINA®



**DB27**

FOR DOBLINA®



**DB28**

FOR DOBLINA®



**DB29**

# MAILBOX KEYS

All keys are in 1:1 scale



FOR DOBLINA®



**DB29R**

FOR DOBLINA®



**DB3**

FOR DOBLINA®



**DB30R**

FOR DOBLINA®



**DB31R**

FOR DOBLINA®



**DB2R**

FOR DOBLINA®



**DB30**

FOR DOBLINA®



**DB31**

FOR DOBLINA®



**DB32**

In compliance with current regulations relating to industrial property, we hereby state that the trade-marks or trade names mentioned in this document are the exclusive property of authorized manufacturers of locks and users. Said trade-marks or trade names are nominated only for the purposes of information so that any lock for which our keys are made can be rapidly identified. This document is reserved exclusively for professional key cutters who use Silca products. / All information and illustrations in this document are for guidance only. Silca reserves the right to alter products designs, dimensions or info to improve the products quality. The contents of this document are fully protected by Copyright and may not be copied or reproduced in any form, without written permission from Silca S.p.A. Any controversy shall be settled by the Courts of Justice where the company Silca S.p.A. has its headquarters, with express exclusion of any other court.

# MAILBOX KEYS

All keys are in 1:1 scale

FOR DOBLINA®



**DB32R**

FOR DOBLINA®



**DB34**

FOR DOBLINA®



**DB35**

FOR DOBLINA®



**DB36**

FOR DOBLINA®



**DB33**

FOR DOBLINA®



**DB34R**

FOR DOBLINA®



**DB35R**

FOR DOBLINA®



**DB36R**



# MAILBOX KEYS

All keys are in 1:1 scale



FOR DOBLINA®



8 0 0 3 7 3 6 0 5 4 1 8 9



DB37

FOR DOBLINA®



8 0 0 3 7 3 6 0 5 4 2 0 2



DB38

FOR DOBLINA®



8 0 0 3 7 3 6 0 5 4 2 2 6



DB39

FOR DOBLINA®



8 0 0 3 7 3 6 0 5 3 9 2 2



DB3R

FOR DOBLINA®



8 0 0 3 7 3 6 0 5 4 1 9 6



DB37R

FOR DOBLINA®



8 0 0 3 7 3 6 0 5 4 2 1 9



DB38R

FOR DOBLINA®



8 0 0 3 7 3 6 0 5 4 2 3 3



DB39R

FOR DOBLINA®



8 0 0 3 7 3 6 0 5 4 2 4 0



DB4

In compliance with current regulations relating to industrial property, we hereby state that the trade-marks or trade names mentioned in this document are the exclusive property of authorized manufacturers of locks and users. Said trade-marks or trade names are nominated only for the purposes of information so that any lock for which our keys are made can be rapidly identified. This document is reserved exclusively for professional key cutters who use Silca products. / All information and illustrations in this document are for guidance only. Silca reserves the right to alter products designs, dimensions or info to improve the products quality. The contents of this document are fully protected by Copyright and may not be copied or reproduced in any form, without written permission from Silca S.p.A. Any controversy shall be settled by the Courts of Justice where the company Silca S.p.A. has its headquarters, with express exclusion of any other court.

# MAILBOX KEYS

All keys are in 1:1 scale

FOR DOBLINA®



**DB40**

FOR DOBLINA®



**DB41**

FOR DOBLINA®



**DB42**

FOR DOBLINA®



**DB43**

FOR DOBLINA®



**DB40R**

FOR DOBLINA®



**DB41R**

FOR DOBLINA®



**DB42R**

FOR DOBLINA®



**DB43R**

# MAILBOX KEYS

All keys are in 1:1 scale



FOR DOBLINA®



**DB44**

FOR DOBLINA®



**DB45**

FOR DOBLINA®



**DB46**

FOR DOBLINA®



**DB47**

FOR DOBLINA®



**DB44R**

FOR DOBLINA®



**DB45R**

FOR DOBLINA®



**DB46R**

FOR DOBLINA®



**DB47R**

In compliance with current regulations relating to industrial property, we hereby state that the trade-marks or trade names mentioned in this document are the exclusive property of authorized manufacturers of locks and users. Said trade-marks or trade names are nominated only for the purposes of information so that any lock for which our keys are made can be rapidly identified. This document is reserved exclusively for professional key cutters who use Silca products. / All information and illustrations in this document are for guidance only. Silca reserves the right to alter products designs, dimensions or info to improve the products quality. The contents of this document are fully protected by Copyright and may not be copied or reproduced in any form, without written permission from Silca S.p.A. Any controversy shall be settled by the Courts of Justice where the company Silca S.p.A. has its headquarters, with express exclusion of any other court.

# MAILBOX KEYS

All keys are in 1:1 scale

FOR DOBLINA®



**DB48**

FOR DOBLINA®



**DB49**

FOR DOBLINA®



**DB4R**

FOR DOBLINA®



**DB50**

FOR DOBLINA®



**DB48R**

FOR DOBLINA®



**DB49R**

FOR DOBLINA®



**DB5**

FOR DOBLINA®



**DB50R**

# MAILBOX KEYS

All keys are in 1:1 scale



FOR DOBLINA®



8 0 0 3 7 3 6 0 5 4 7 4 5



**DB51**

FOR DOBLINA®



8 0 0 3 7 3 6 0 5 4 7 8 3



**DB53**

FOR DOBLINA®



8 0 0 3 7 3 6 0 5 4 8 2 0



**DB54**

FOR DOBLINA®



8 0 0 3 7 3 6 0 5 4 8 6 8



**DB55**

FOR DOBLINA®



8 0 0 3 7 3 6 0 5 4 7 6 9



**DB51R**

FOR DOBLINA®



8 0 0 3 7 3 6 0 5 4 8 0 6



**DB53R**

FOR DOBLINA®



8 0 0 3 7 3 6 0 5 4 8 4 4



**DB54R**

FOR DOBLINA®



8 0 0 3 7 3 6 0 5 4 8 8 2



**DB55R**

In compliance with current regulations relating to industrial property, we hereby state that the trade-marks or trade names mentioned in this document are the exclusive property of authorized manufacturers of locks and users. Said trade-marks or trade names are nominated only for the purposes of information so that any lock for which our keys are made can be rapidly identified. This document is reserved exclusively for professional key cutters who use Silca products. / All information and illustrations in this document are for guidance only. Silca reserves the right to alter products designs, dimensions or info to improve the products quality. The contents of this document are fully protected by Copyright and may not be copied or reproduced in any form, without written permission from Silca S.p.A. Any controversy shall be settled by the Courts of Justice where the company Silca S.p.A. has its headquarters, with express exclusion of any other court.

# MAILBOX KEYS

All keys are in 1:1 scale

FOR DOBLINA®



**DB56**

FOR DOBLINA®



**DB57**

FOR DOBLINA®



**DB58**

FOR DOBLINA®



**DB59**

FOR DOBLINA®



**DB56R**

FOR DOBLINA®



**DB57R**

FOR DOBLINA®



**DB58R**

FOR DOBLINA®



**DB59R**

# MAILBOX KEYS

All keys are in 1:1 scale



FOR DOBLINA®



**DB5R**

FOR DOBLINA®



**DB60**

FOR DOBLINA®



**DB7**

FOR DOBLINA®



**DB8**

FOR DOBLINA®



**DB6**

FOR DOBLINA®



**DB6R**

FOR DOBLINA®



**DB7R**

FOR DOBLINA®



**DB8R**

In compliance with current regulations relating to industrial property, we hereby state that the trade-marks or trade names mentioned in this document are the exclusive property of authorized manufacturers of locks and users. Said trade-marks or trade names are nominated only for the purposes of information so that any lock for which our keys are made can be rapidly identified. This document is reserved exclusively for professional key cutters who use Silca products. / All information and illustrations in this document are for guidance only. Silca reserves the right to alter products designs, dimensions or info to improve the products quality. The contents of this document are fully protected by Copyright and may not be copied or reproduced in any form, without written permission from Silca S.p.A. Any controversy shall be settled by the Courts of Justice where the company Silca S.p.A. has its headquarters, with express exclusion of any other court.

# MAILBOX KEYS

All keys are in 1:1 scale

FOR DOBLINA®



**DB9**

FOR DOM®



**DM128**

FOR DOM®



**DM58**

FOR ELKO®



**ELK1**

FOR DOBLINA®



**DB9R**

FOR DOM®



**DM55**

FOR DOMINION®



**D013**

FOR FAB®



**FB36**



# MAILBOX KEYS

All keys are in 1:1 scale



FOR FAB®



8 0 0 3 7 3 7 4 8 1 1 4 4



**FB36R**

FOR FIST®



8 0 0 3 7 3 6 5 5 9 6 1 5



**FIS1R**

FOR FRANZEN®



8 0 0 3 7 3 7 8 0 8 4 5 3



**FRE1R**

FOR GEGE®



8 0 0 3 7 3 6 0 7 6 7 3 0



**GE19R**

FOR FIST®



8 0 0 3 7 3 6 5 5 9 5 9 2



**FIS1**

FOR FIST®



8 0 0 3 7 3 6 0 7 2 3 2 9



**FIS3**

FOR GEGE®



8 0 0 3 7 3 6 0 7 6 6 8 6



**GE18**

FOR GEGE®



8 0 0 3 7 3 6 5 6 0 0 1 7



**GE20**

In compliance with current regulations relating to industrial property, we hereby state that the trade-marks or trade names mentioned in this document are the exclusive property of authorized manufacturers of locks and users. Said trade-marks or trade names are nominated only for the purposes of information so that any lock for which our keys are made can be rapidly identified. This document is reserved exclusively for professional key cutters who use Silca products. / All information and illustrations in this document are for guidance only. Silca reserves the right to alter products designs, dimensions or info to improve the products quality. The contents of this document are fully protected by Copyright and may not be copied or reproduced in any form, without written permission from Silca S.p.A. Any controversy shall be settled by the Courts of Justice where the company Silca S.p.A. has its headquarters, with express exclusion of any other court.

# MAILBOX KEYS

All keys are in 1:1 scale

FOR GEGE®



8 0 0 3 7 3 6 0 7 6 8 3 9



**GE21R**

FOR GEGE®



8 0 0 3 7 3 6 0 7 6 9 0 7



**GE23**

FOR GEGE®



8 0 0 3 7 3 6 0 7 6 9 6 9



**GE24**

FOR GEGE®



8 0 0 3 7 3 6 0 7 7 0 2 7



**GE25**

FOR GEGE®



8 0 0 3 7 3 6 5 6 0 0 4 8



**GE22**

FOR GEGE®



8 0 0 3 7 3 6 0 7 6 9 3 8



**GE23R**

FOR GEGE®



8 0 0 3 7 3 6 0 7 6 9 9 0



**GE24R**

FOR GEGE®



8 0 0 3 7 3 6 5 6 0 0 5 5



**GE25R**

In compliance with current regulations relating to industrial property, we hereby state that the trade-marks or trade names mentioned in this document are the exclusive property of authorized manufacturers of locks and users. Said trade-marks or trade names are nominated only for the purposes of information so that any lock for which our keys are made can be rapidly identified. This document is reserved exclusively for professional key cutters who use Silca products. / All information and illustrations in this document are for guidance only. Silca reserves the right to alter products designs, dimensions or info to improve the products quality. The contents of this document are fully protected by Copyright and may not be copied or reproduced in any form, without written permission from Silca S.p.A. Any controversy shall be settled by the Courts of Justice where the company Silca S.p.A. has its headquarters, with express exclusion of any other court.

# MAILBOX KEYS

All keys are in 1:1 scale



FOR GEGE®



8 0 0 3 7 3 6 5 6 0 9 3



**GE26**

FOR GEGE®



8 0 0 3 7 3 6 5 6 0 1 1 6



**GE27**

FOR GEGE®



8 0 0 3 7 3 6 7 8 1 1 3 9



**GE28**

FOR GEGE®



8 0 0 3 7 3 6 0 7 7 2 1 8



**GE29**

FOR GEGE®



8 0 0 3 7 3 6 0 7 7 1 0 2



**GE26R**

FOR GEGE®



8 0 0 3 7 3 6 7 6 6 2 5 9



**GE27R**

FOR GEGE®



8 0 0 3 7 3 6 0 7 7 1 8 8



**GE28R**

FOR GEGE®



8 0 0 3 7 3 6 0 7 7 2 3 2



**GE29R**

In compliance with current regulations relating to industrial property, we hereby state that the trade-marks or trade names mentioned in this document are the exclusive property of authorized manufacturers of locks and users. Said trade-marks or trade names are nominated only for the purposes of information so that any lock for which our keys are made can be rapidly identified. This document is reserved exclusively for professional key cutters who use Silca products. / All information and illustrations in this document are for guidance only. Silca reserves the right to alter products designs, dimensions or info to improve the products quality. The contents of this document are fully protected by Copyright and may not be copied or reproduced in any form, without written permission from Silca S.p.A. Any controversy shall be settled by the Courts of Justice where the company Silca S.p.A. has its headquarters, with express exclusion of any other court.

# MAILBOX KEYS

All keys are in 1:1 scale

FOR GEGE®



8 0 0 3 7 3 6 0 7 7 3 9 3



**GE30**

FOR GEGE®



8 0 0 3 7 3 6 0 7 7 4 4 7



**GE31**

FOR GIUSSANI®



8 0 0 3 7 3 6 0 8 4 8 1 0



**GS13**

FOR HOPPE®



8 0 0 3 7 3 7 8 3 6 7 7 7



**HPP1**

FOR GEGE®



8 0 0 3 7 3 6 0 7 7 4 2 3



**GE30R**

FOR GEGE®



8 0 0 3 7 3 6 7 8 1 1 4 6



**GE31R**

FOR GIUSSANI®



8 0 0 3 7 3 6 0 8 4 9 3 3



**GS4R**

FOR HOPPE®



8 0 0 3 7 3 6 5 0 3 4 9 6



**HPP1R**

# MAILBOX KEYS

All keys are in 1:1 scale



FOR I.B.F.M.®



1002

FOR IBFM®



IBF1R

FOR JU®



JU11R

FOR JU®



JU13R

FOR IBFM®



IBF1

FOR JU®



JU11

FOR JU®



JU12

FOR LAMA®



LMA1

In compliance with current regulations relating to industrial property, we hereby state that the trade-marks or trade names mentioned in this document are the exclusive property of authorized manufacturers of locks and users. Said trade-marks or trade names are nominated only for the purposes of information so that any lock for which our keys are made can be rapidly identified. This document is reserved exclusively for professional key cutters who use Silca products. / All information and illustrations in this document are for guidance only. Silca reserves the right to alter products designs, dimensions or info to improve the products quality. The contents of this document are fully protected by Copyright and may not be copied or reproduced in any form, without written permission from Silca S.p.A. Any controversy shall be settled by the Courts of Justice where the company Silca S.p.A. has its headquarters, with express exclusion of any other court.

# MAILBOX KEYS

All keys are in 1:1 scale

FOR LOWE & F.®



8 0 0 3 7 3 7 9 0 4 8 2 7



**LF62**

FOR LOWE & FLETCHER®



8 0 0 3 7 3 7 5 8 3 1 7 6



**LF59R**

FOR LOWE & FLETCHER®



8 0 0 3 7 3 7 6 9 7 2 0 0



**LF61R**

FOR MICHEL-SEAT®



8 0 0 3 7 3 6 5 6 4 1 1 4



**MH3**

FOR LOWE & FLETCHER®



8 0 0 3 7 3 7 5 8 3 1 5 2



**LF58R**

FOR LOWE & FLETCHER®



8 0 0 3 7 3 7 6 4 2 5 8 3



**LF60**

FOR MANETTI®



8 0 0 3 7 3 6 0 0 7 3 7 6



**AMA1**

FOR MICHEL-SEAT®



8 0 0 3 7 3 6 5 6 4 1 3 8



**MH5**

In compliance with current regulations relating to industrial property, we hereby state that the trade-marks or trade names mentioned in this document are the exclusive property of authorized manufacturers of locks and users. Said trade-marks or trade names are nominated only for the purposes of information so that any lock for which our keys are made can be rapidly identified. This document is reserved exclusively for professional key cutters who use Silca products. / All information and illustrations in this document are for guidance only. Silca reserves the right to alter products designs, dimensions or info to improve the products quality. The contents of this document are fully protected by Copyright and may not be copied or reproduced in any form, without written permission from Silca S.p.A. Any controversy shall be settled by the Courts of Justice where the company Silca S.p.A. has its headquarters, with express exclusion of any other court.

# MAILBOX KEYS

All keys are in 1:1 scale



FOR MICHEL-SEAT®



**MH5R**

FOR MILES®



**MIS2**

FOR MOBELLA®



**MBS301**

FOR MUEL®



**MU402**

FOR MILES®



**MIS1**

FOR MOBELLA®



**MBS300**

FOR MUEL®



**MU401**

FOR MUEL®

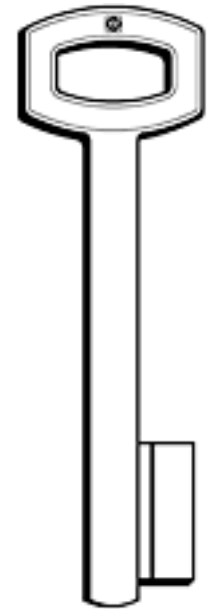

**MU403**

In compliance with current regulations relating to industrial property, we hereby state that the trade-marks or trade names mentioned in this document are the exclusive property of authorized manufacturers of locks and users. Said trade-marks or trade names are nominated only for the purposes of information so that any lock for which our keys are made can be rapidly identified. This document is reserved exclusively for professional key cutters who use Silca products. / All information and illustrations in this document are for guidance only. Silca reserves the right to alter products designs, dimensions or info to improve the products quality. The contents of this document are fully protected by Copyright and may not be copied or reproduced in any form, without written permission from Silca S.p.A. Any controversy shall be settled by the Courts of Justice where the company Silca S.p.A. has its headquarters, with express exclusion of any other court.

# MAILBOX KEYS

All keys are in 1:1 scale

FOR MUEL®



**MU404**

FOR O.M.R.®



**OMR1R**

FOR PERINO®

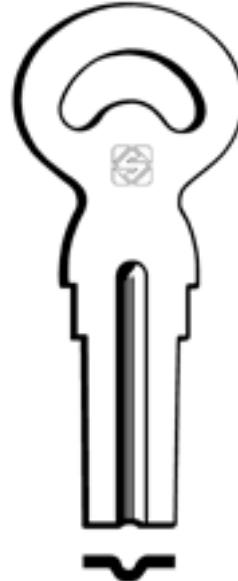

**APE1**

FOR PERINO®

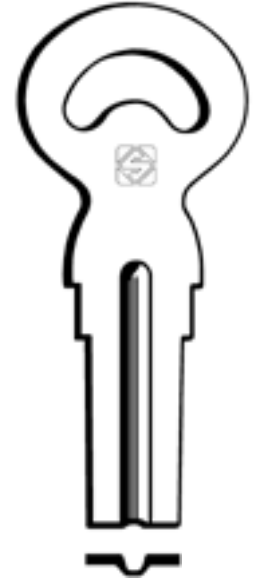

**APE2**

FOR NEPTUNE®



**NP1R**

FOR OSTERTAG®

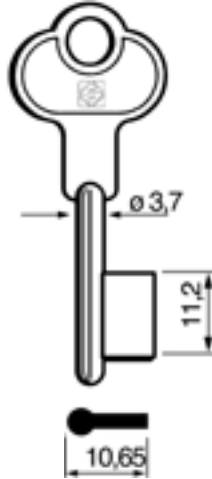

**60G1**

FOR PERINO®

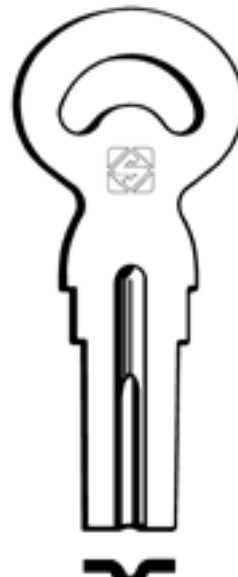

**APE1F**

FOR RENZ®



**REN1**



# MAILBOX KEYS

All keys are in 1:1 scale



FOR RENZ®



8 0 0 3 7 3 6 1 3 7 0 5 9



REN1R

FOR RENZ®



8 0 0 3 7 3 6 7 6 1 0 1 8



REN3R

FOR ROMA®



8 0 0 3 7 3 6 0 0 7 7 8 9



AR01

FOR S.I.C.E.M.®



8 0 0 3 7 3 6 0 0 8 2 1 2



ASI1

FOR RENZ®



8 0 0 3 7 3 6 3 0 9 6 1 6



REN2R

FOR RIL®



8 0 0 3 7 3 6 1 3 8 0 5 6



RL1

FOR RONIS®



8 0 0 3 7 3 6 1 3 9 4 3 5



R041

FOR S.I.C.E.M.®



8 0 0 3 7 3 6 0 0 8 2 2 9



ASI2

In compliance with current regulations relating to industrial property, we hereby state that the trade-marks or trade names mentioned in this document are the exclusive property of authorized manufacturers of locks and users. Said trade-marks or trade names are nominated only for the purposes of information so that any lock for which our keys are made can be rapidly identified. This document is reserved exclusively for professional key cutters who use Silca products. / All information and illustrations in this document are for guidance only. Silca reserves the right to alter products designs, dimensions or info to improve the products quality. The contents of this document are fully protected by Copyright and may not be copied or reproduced in any form, without written permission from Silca S.p.A. Any controversy shall be settled by the Courts of Justice where the company Silca S.p.A. has its headquarters, with express exclusion of any other court.

# MAILBOX KEYS

All keys are in 1:1 scale

FOR SABIEM®



ASAB1

FOR SARGENT®



SAR1032

FOR SEAT®



SEA4R

FOR SEAT®



SEA5R

FOR SARGENT®



SAR1031

FOR SEAT®



SEA4

FOR SEAT®



SEA5

FOR SEAT®



SEA7

In compliance with current regulations relating to industrial property, we hereby state that the trade-marks or trade names mentioned in this document are the exclusive property of authorized manufacturers of locks and users. Said trade-marks or trade names are nominated only for the purposes of information so that any lock for which our keys are made can be rapidly identified. This document is reserved exclusively for professional key cutters who use Silca products. / All information and illustrations in this document are for guidance only. Silca reserves the right to alter products designs, dimensions or info to improve the products quality. The contents of this document are fully protected by Copyright and may not be copied or reproduced in any form, without written permission from Silca S.p.A. Any controversy shall be settled by the Courts of Justice where the company Silca S.p.A. has its headquarters, with express exclusion of any other court.

# MAILBOX KEYS

All keys are in 1:1 scale



FOR SEAT®



8 0 0 3 7 3 6 5 6 6 6 8 2



SEA8

FOR SIS®



8 0 0 3 7 3 6 8 4 6 3 9 5



SS14

FOR STIGLER®



8 0 0 3 7 3 6 0 1 6 3 1 6



AST1

FOR TOKOZ®



8 0 0 3 7 3 7 8 7 9 4 2 2

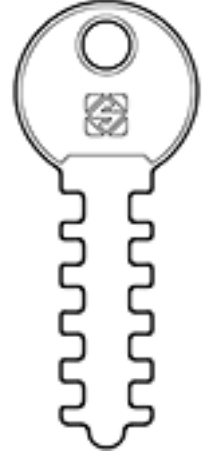

TOZ13

FOR SERRETA®



8 0 0 3 7 3 6 0 5 0 5 1 8

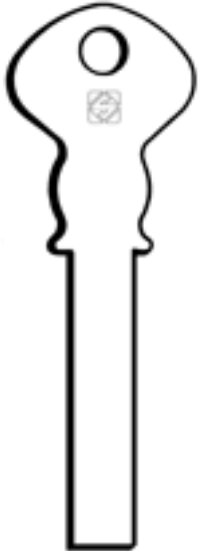

CX7

FOR SIS®



8 0 0 3 7 3 6 8 4 6 4 1 8



SS14R

FOR STUV®



8 0 0 3 7 3 6 2 2 8 3 0 6

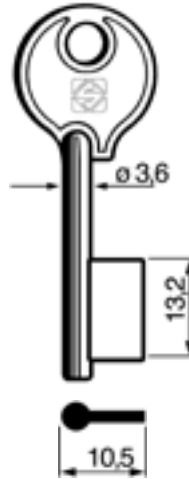

6SV1

FOR TOKOZ®



8 0 0 3 7 3 7 8 7 9 4 3 9



TOZ14

In compliance with current regulations relating to industrial property, we hereby state that the trade-marks or trade names mentioned in this document are the exclusive property of authorized manufacturers of locks and users. Said trade-marks or trade names are nominated only for the purposes of information so that any lock for which our keys are made can be rapidly identified. This document is reserved exclusively for professional key cutters who use Silca products. / All information and illustrations in this document are for guidance only. Silca reserves the right to alter products designs, dimensions or info to improve the products quality. The contents of this document are fully protected by Copyright and may not be copied or reproduced in any form, without written permission from Silca S.p.A. Any controversy shall be settled by the Courts of Justice where the company Silca S.p.A. has its headquarters, with express exclusion of any other court.

# MAILBOX KEYS

All keys are in 1:1 scale

FOR UNION®



8 0 0 3 7 3 6 1 7 1 2 0 6



**UNI1010**

FOR ZEISS IKON®



8 0 0 3 7 3 6 5 7 4 0 1 4



**ZE3**

FOR ZEISS IKON®



8 0 0 3 7 3 6 3 1 6 1 6 4



**ZE4**

FOR ZEISS IKON®



8 0 0 3 7 3 6 5 7 4 0 5 2



**ZE5R**

FOR YALE®



8 0 0 3 7 3 6 1 9 3 3 2 1



**YA1007**

FOR ZEISS IKON®



8 0 0 3 7 3 6 5 7 4 0 3 8



**ZE3R**

FOR ZEISS IKON®



8 0 0 3 7 3 6 3 1 6 1 7 1



**ZE5**

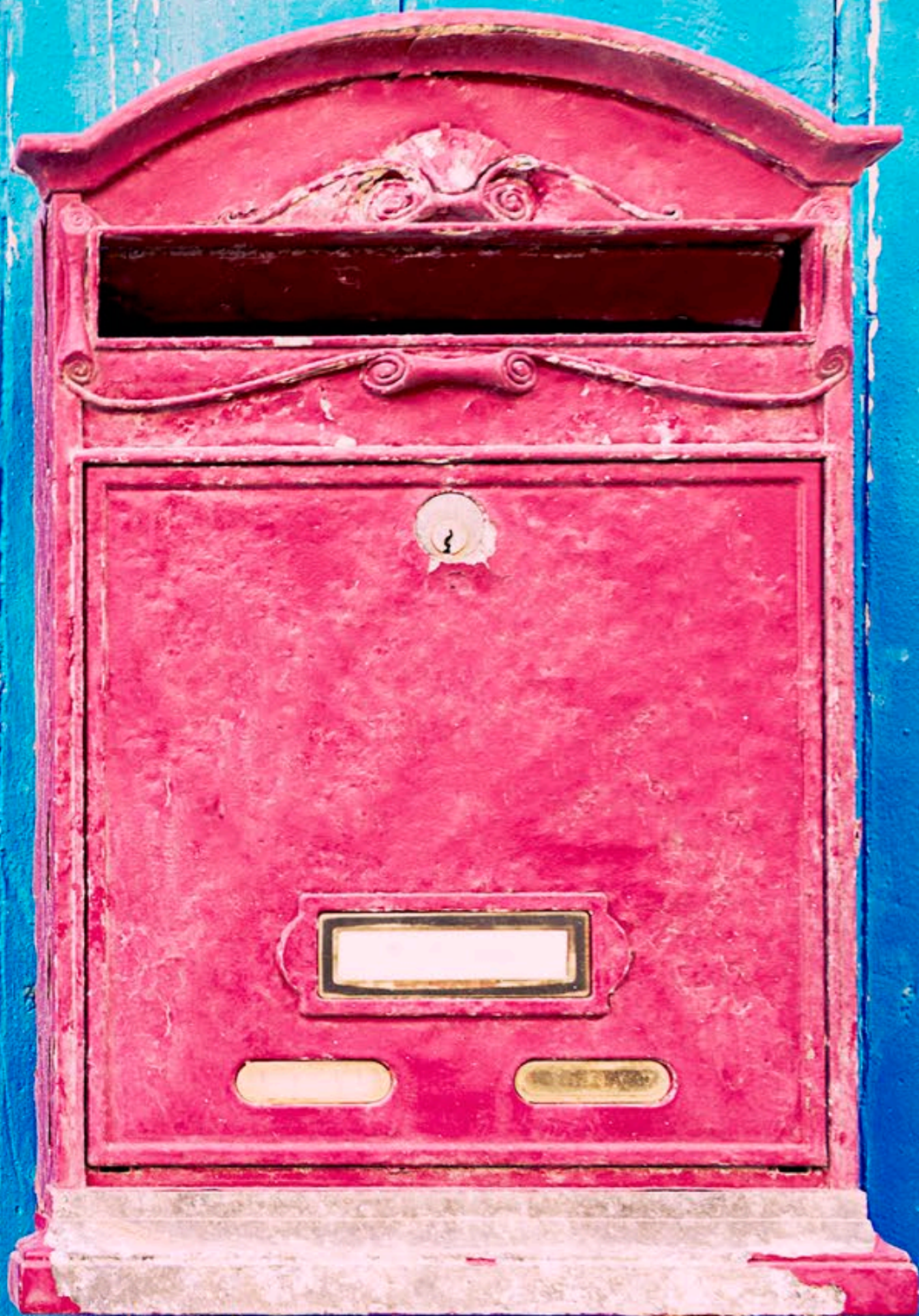

# GENERAL INDEX

INDICE GENERALE · GENERALVERZEICHNIS · INDEX GÉNÉRAL

INDICE GENERAL · ÍNDICE GERAL · ALGEMENE INDEX



<b>1000</b>	1	<b>CU412</b>	6	<b>DB35R</b>	14	<b>DB8R</b>	21
<b>1001</b>	1	<b>CU413</b>	5	<b>DB36</b>	14	<b>DB9</b>	22
<b>1002</b>	27	<b>CX7</b>	33	<b>DB36R</b>	14	<b>DB9R</b>	22
<b>1003P</b>	1	<b>DB1</b>	7	<b>DB37</b>	15	<b>DD8</b>	7
<b>1003P1</b>	1	<b>DB10</b>	7	<b>DB37R</b>	15	<b>DM128</b>	22
<b>1004</b>	4	<b>DB10R</b>	8	<b>DB38</b>	15	<b>DM55</b>	22
<b>1005</b>	4	<b>DB11</b>	8	<b>DB38R</b>	15	<b>DM58</b>	22
<b>1008</b>	1	<b>DB11R</b>	8	<b>DB39</b>	15	<b>D013</b>	22
<b>1009</b>	1	<b>DB12</b>	8	<b>DB39R</b>	15	<b>ELK1</b>	22
<b>1012</b>	1	<b>DB12R</b>	8	<b>DB3R</b>	15	<b>FB36</b>	22
<b>1013</b>	1	<b>DB13</b>	8	<b>DB4</b>	15	<b>FB36R</b>	23
<b>1014</b>	2	<b>DB13R</b>	8	<b>DB40</b>	16	<b>FIS1</b>	23
<b>1015</b>	2	<b>DB14</b>	8	<b>DB40R</b>	16	<b>FIS1R</b>	23
<b>1016</b>	2	<b>DB14R</b>	9	<b>DB41</b>	16	<b>FIS3</b>	23
<b>60G1</b>	30	<b>DB15</b>	9	<b>DB41R</b>	16	<b>FRE1R</b>	23
<b>6SV1</b>	33	<b>DB15R</b>	9	<b>DB42</b>	16	<b>GE18</b>	23
<b>ALU1</b>	2	<b>DB16</b>	9	<b>DB42R</b>	16	<b>GE19R</b>	23
<b>AMA1</b>	28	<b>DB16R</b>	9	<b>DB43</b>	16	<b>GE20</b>	23
<b>APE1</b>	30	<b>DB17</b>	9	<b>DB43R</b>	16	<b>GE21R</b>	24
<b>APE1F</b>	30	<b>DB17R</b>	9	<b>DB44</b>	17	<b>GE22</b>	24
<b>APE2</b>	30	<b>DB18</b>	9	<b>DB44R</b>	17	<b>GE23</b>	24
<b>ARO1</b>	31	<b>DB18R</b>	10	<b>DB45</b>	17	<b>GE23R</b>	24
<b>ART1</b>	2	<b>DB19</b>	10	<b>DB45R</b>	17	<b>GE24</b>	24
<b>ART1R</b>	2	<b>DB19R</b>	10	<b>DB46</b>	17	<b>GE24R</b>	24
<b>ASAB1</b>	32	<b>DB1R</b>	10	<b>DB46R</b>	17	<b>GE25</b>	24
<b>ASI1</b>	31	<b>DB2</b>	10	<b>DB47</b>	17	<b>GE25R</b>	24
<b>ASI2</b>	31	<b>DB20</b>	10	<b>DB47R</b>	17	<b>GE26</b>	25
<b>ASS187R</b>	2	<b>DB20R</b>	10	<b>DB48</b>	18	<b>GE26R</b>	25
<b>AST1</b>	33	<b>DB21</b>	10	<b>DB48R</b>	18	<b>GE27</b>	25
<b>BUR28R</b>	3	<b>DB21R</b>	11	<b>DB49</b>	18	<b>GE27R</b>	25
<b>BUR31</b>	3	<b>DB22</b>	11	<b>DB49R</b>	18	<b>GE28</b>	25
<b>BUR31R</b>	3	<b>DB22R</b>	11	<b>DB4R</b>	18	<b>GE28R</b>	25
<b>CAB1</b>	3	<b>DB23</b>	11	<b>DB5</b>	18	<b>GE29</b>	25
<b>CAX1R</b>	4	<b>DB23R</b>	11	<b>DB50</b>	18	<b>GE29R</b>	25
<b>CH15</b>	4	<b>DB24</b>	11	<b>DB50R</b>	18	<b>GE30</b>	26
<b>CIS1</b>	3	<b>DB24R</b>	11	<b>DB51</b>	19	<b>GE30R</b>	26
<b>CIS2</b>	3	<b>DB25</b>	11	<b>DB51R</b>	19	<b>GE31</b>	26
<b>CIS3</b>	3	<b>DB25R</b>	12	<b>DB53</b>	19	<b>GE31R</b>	26
<b>CIS4</b>	3	<b>DB26</b>	12	<b>DB53R</b>	19	<b>GS13</b>	26
<b>CIS4R</b>	4	<b>DB26R</b>	12	<b>DB54</b>	19	<b>GS4R</b>	26
<b>CR2R</b>	5	<b>DB27</b>	12	<b>DB54R</b>	19	<b>HPP1</b>	26
<b>CRE401</b>	6	<b>DB27R</b>	12	<b>DB55</b>	19	<b>HPP1R</b>	26
<b>CRE402</b>	7	<b>DB28</b>	12	<b>DB55R</b>	19	<b>IBF1</b>	27
<b>CRE403</b>	7	<b>DB28R</b>	12	<b>DB56</b>	20	<b>IBF1R</b>	27
<b>CRE404</b>	7	<b>DB29</b>	12	<b>DB56R</b>	20	<b>JU11</b>	27
<b>CRE405</b>	7	<b>DB29R</b>	13	<b>DB57</b>	20	<b>JU11R</b>	27
<b>CRE406</b>	7	<b>DB2R</b>	13	<b>DB57R</b>	20	<b>JU12</b>	27
<b>CS1003</b>	5	<b>DB3</b>	13	<b>DB58</b>	20	<b>JU13R</b>	27
<b>CU401</b>	5	<b>DB30</b>	13	<b>DB58R</b>	20	<b>LF58R</b>	28
<b>CU402</b>	5	<b>DB30R</b>	13	<b>DB59</b>	20	<b>LF59R</b>	28
<b>CU403</b>	6	<b>DB31</b>	13	<b>DB59R</b>	20	<b>LF60</b>	28
<b>CU404</b>	6	<b>DB31R</b>	13	<b>DB5R</b>	21	<b>LF61R</b>	28
<b>CU405</b>	5	<b>DB32</b>	13	<b>DB6</b>	21	<b>LF62</b>	28
<b>CU406</b>	6	<b>DB32R</b>	14	<b>DB60</b>	21	<b>LMA1</b>	27
<b>CU407</b>	6	<b>DB33</b>	14	<b>DB6R</b>	21	<b>MBS300</b>	29
<b>CU408</b>	6	<b>DB34</b>	14	<b>DB7</b>	21	<b>MBS301</b>	29
<b>CU409</b>	5	<b>DB34R</b>	14	<b>DB7R</b>	21	<b>MH3</b>	28
<b>CU411</b>	6	<b>DB35</b>	14	<b>DB8</b>	21	<b>MH5</b>	28

In compliance with current regulations relating to industrial property, we hereby state that the trade-marks or trade names mentioned in this document are the exclusive property of authorized manufacturers of locks and users. Said trade-marks or trade names are nominated only for the purposes of information so that any lock for which our keys are made can be rapidly identified. This document is reserved exclusively for professional key cutters who use Silca products. / All information and illustrations in this document are for guidance only. Silca reserves the right to alter products designs, dimensions or info to improve the products quality. The contents of this document are fully protected by Copyright and may not be copied or reproduced in any form, without written permission from Silca S.p.A. Any controversy shall be settled by the Courts of Justice where the company Silca S.p.A. has its headquarters, with express exclusion of any other court.



# INDEX

<b>MH5R</b>	29
<b>MIS1</b>	29
<b>MIS2</b>	29
<b>MU401</b>	29
<b>MU402</b>	29
<b>MU403</b>	29
<b>MU404</b>	30
<b>NP1R</b>	30
<b>NR1R</b>	2
<b>OMR1R</b>	30
<b>RC13R</b>	4
<b>RC6</b>	4
<b>RC6R</b>	4
<b>RC7R</b>	5
<b>REN1</b>	30
<b>REN1R</b>	31
<b>REN2R</b>	31
<b>REN3R</b>	31
<b>RL1</b>	31
<b>RO41</b>	31
<b>SAR1031</b>	32
<b>SAR1032</b>	32
<b>SEA4</b>	32
<b>SEA4R</b>	32
<b>SEA5</b>	32
<b>SEA5R</b>	32
<b>SEA7</b>	32
<b>SEA8</b>	33
<b>SS14</b>	33
<b>SS14R</b>	33
<b>TOZ13</b>	33
<b>TOZ14</b>	33
<b>UNI1010</b>	34
<b>YA1007</b>	34
<b>ZE3</b>	34
<b>ZE3R</b>	34
<b>ZE4</b>	34
<b>ZE5</b>	34
<b>ZE5R</b>	34







**ITALY  
AND OTHER COUNTRIES  
SILCA S.p.A.**

Via Podgora, 20 (Z.I.)  
31029 VITTORIO VENETO (TV)  
Tel. +39 0438 9136  
Fax +39 0438 913800  
E-mail: [silca@silca.it](mailto:silca@silca.it)  
[www.silca.biz](http://www.silca.biz) - [www.silca.it](http://www.silca.it)

**FRANCE  
SILCA S.A.S.**

12, Rue de Rouen  
Z.I. Limay-Porcheville  
78440 PORCHEVILLE  
Phone: +33 1 30983500  
Fax +33 1 30983501  
E-mail: [info@silca.fr](mailto:info@silca.fr)  
[www.silca.fr](http://www.silca.fr)

**SPAIN  
SILCA KEY SYSTEMS S.A.**

C/Santander 73A  
08020 BARCELONA  
Phone: +34 93 4981400  
Fax +34 93 2788004  
E-mail: [silca@silca.es](mailto:silca@silca.es)  
[www.silca.es](http://www.silca.es)

**GERMANY  
SILCA GmbH**

Siemensstrasse, 33  
42551 VELBERT  
Phone: +49 2051 2710  
Fax +49 2051 271172  
E-mail: [info@silca.de](mailto:info@silca.de)  
[www.silca.de](http://www.silca.de)

**UNITED KINGDOM  
SILCA**

Unit 6 Lloyds Court  
Manor Royal  
RH10 9QU CRAWLEY  
Phone: +44 1293 531134  
Fax +44 1293 531108  
E-mail: [sales@silcald.co.uk](mailto:sales@silcald.co.uk)  
[www.silcald.co.uk](http://www.silcald.co.uk)

**BENELUX  
H. CILLEKENS & B.V.**

Metaalweg, 4  
6045 JB ROERMOND  
Phone: +31 475 325147  
Fax +31 475 323640  
E-mail: [info@hcillekens.nl](mailto:info@hcillekens.nl)  
[www.hcillekens.nl](http://www.hcillekens.nl)

**UNITED KINGDOM  
ADVANCED DIAGNOSTICS Ltd.**

Eastboro Fields  
Hemdale Business Park  
CV11 6GL NUNEATON  
Phone: +44 2476 347000  
Fax + 44 2476 347100  
E-mail: [sales@advanced-diagnostics.com](mailto:sales@advanced-diagnostics.com)  
[www.advanced-diagnostics.com](http://www.advanced-diagnostics.com)



dormakaba Group